



PALMBERG Büroeinrichtungen + Service GmbH  
Am Palmberg 9 · 23923 Schönberg  
Tel. +49 38828 38-0 · Fax +49 38828 38-136  
info@palmberg.de · www.palmberg.de

PALMBERG (Schweiz) AG  
Werkstrasse 17 · 8222 Beringen  
Tel. +41 62 888 80 00 · Fax +41 62 888 80 09  
info@palmberg.ch · www.palmberg.ch

PALMBERG Büroeinrichtungen + Service GmbH  
Rietveldenweg 47 · 5222 AP 's-Hertogenbosch  
Tel. +31 411 689522 · Fax +31 411 689479  
info@palmberg.nl · www.palmberg.nl



## PLATTENÜBERSICHT

OVERVIEW OF BOARDS  
OVERZICHT BLADVORMEN

PALMBERG Produkte werden ausschließlich über autorisierte Fachhändler angeboten, um Ihnen ein Höchstmaß an Service und Bürokompetenz zu gewährleisten. Wenden Sie sich daher an:



Grundplatten · Basic boards · Bureaus

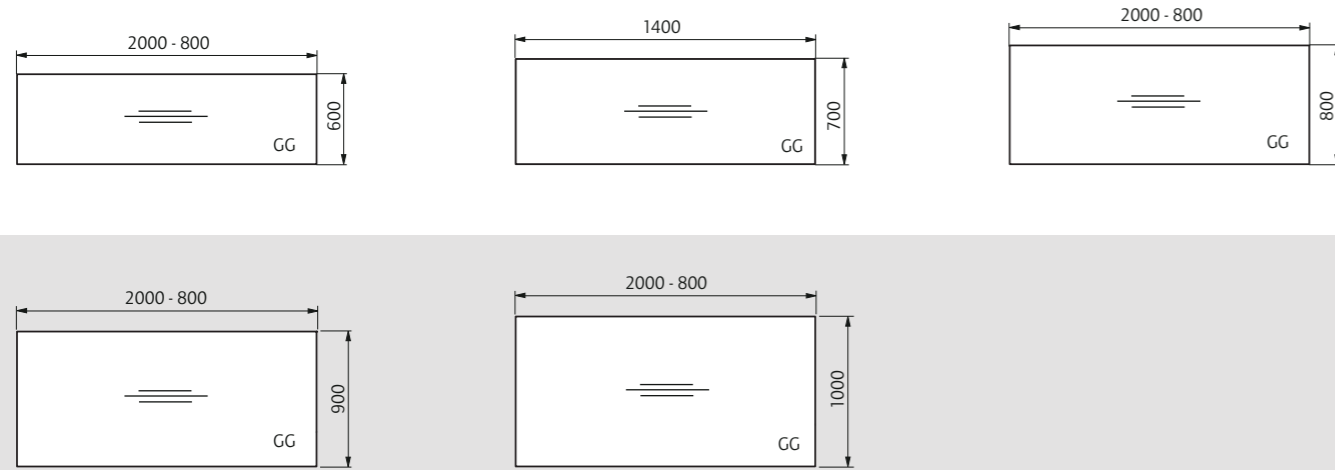

Besprechungstische · Conference tables · Vergadertafels

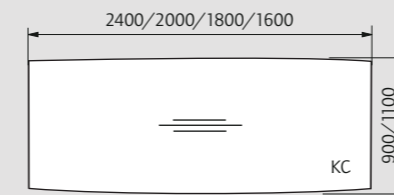
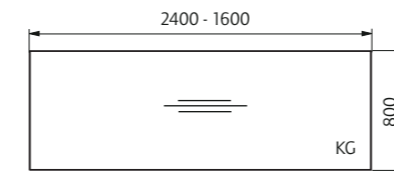
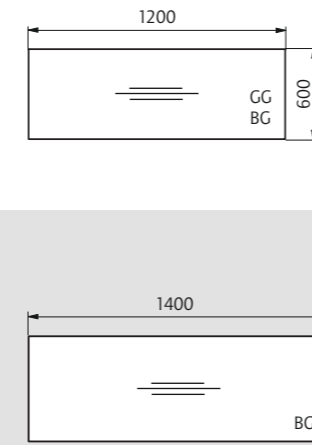

Trapeztische · Trapezoid tables · Trapeziumtafels

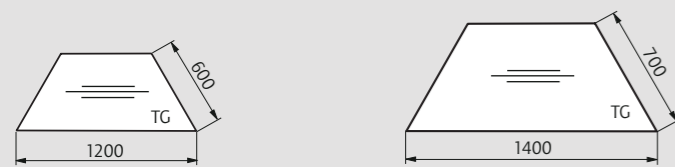

Unsere Tischplatten sind in verschiedenen Materialausführungen wählbar. Alle Plattenmaterialien mit einer Melaminharzbeschichtung entsprechen der Emissionsklasse E1 nach DIN EN 14322.

Our tabletops are available in different material designs. All board materials with a melamine resin coating comply with the E1 emission class according to DIN EN 14322.

Bureaubladen zijn in verschillende materiaalluitvoeringen verkrijgbaar. Alle plaatmaterialen met een melamine coating laag voldoen aan de emissieklasse E1 volgens DIN EN 14322.

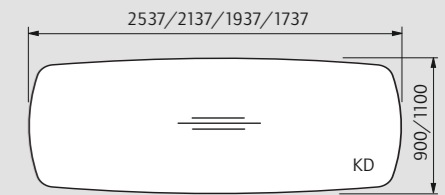
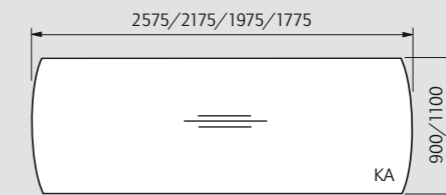
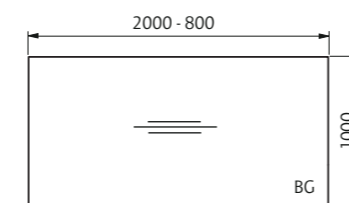
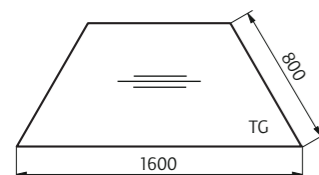

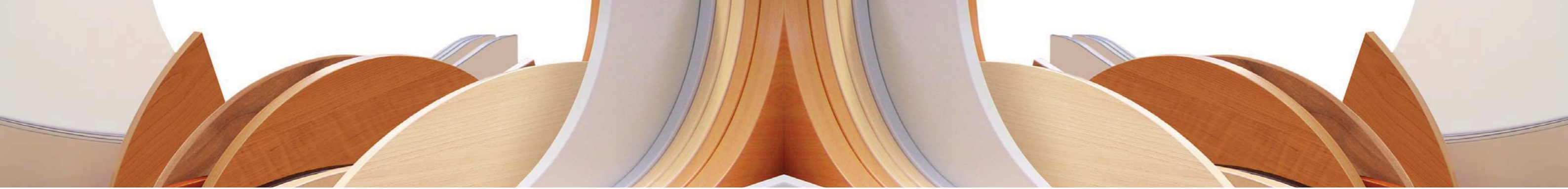

COM-Arbeitsplätze · COM workstations · COM werkplekken

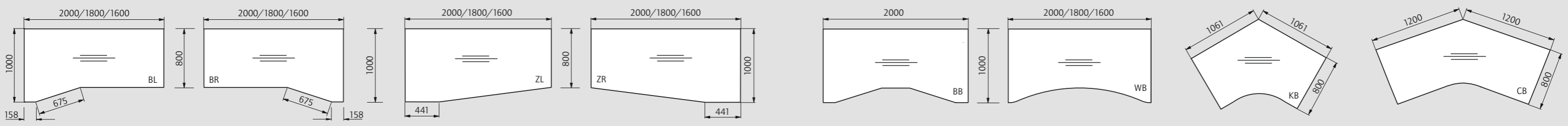
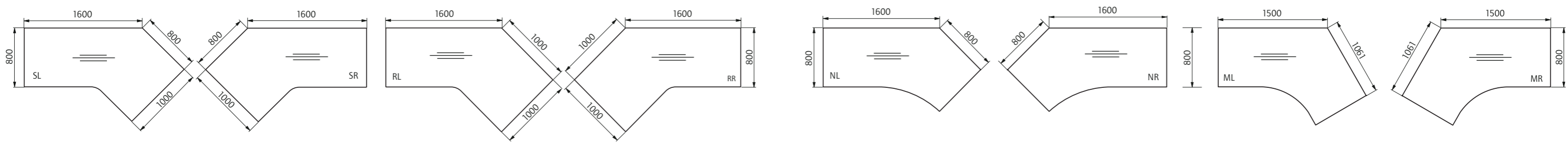
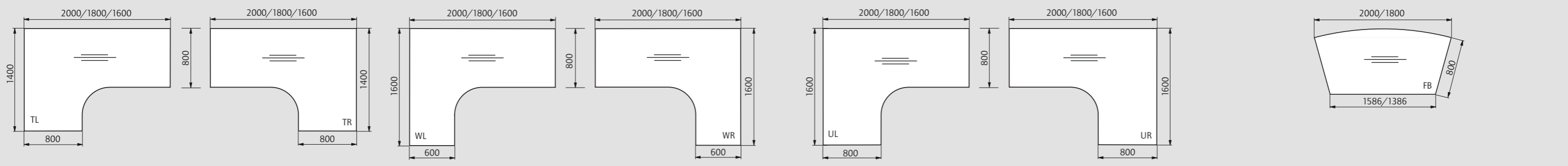
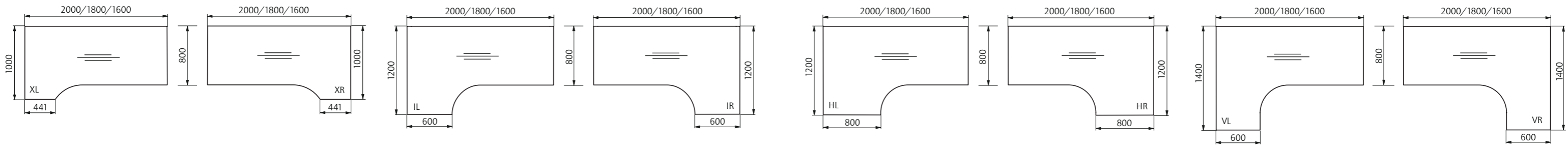



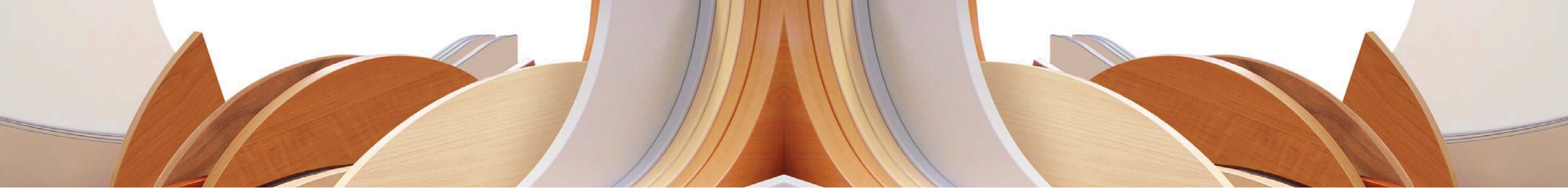

**Ansatzэлементы · Modular attachments · Aanbouwelementen**

linke und rechte Ausführung erhältlich · left and right version available · linker en rechter versie beschikbaar

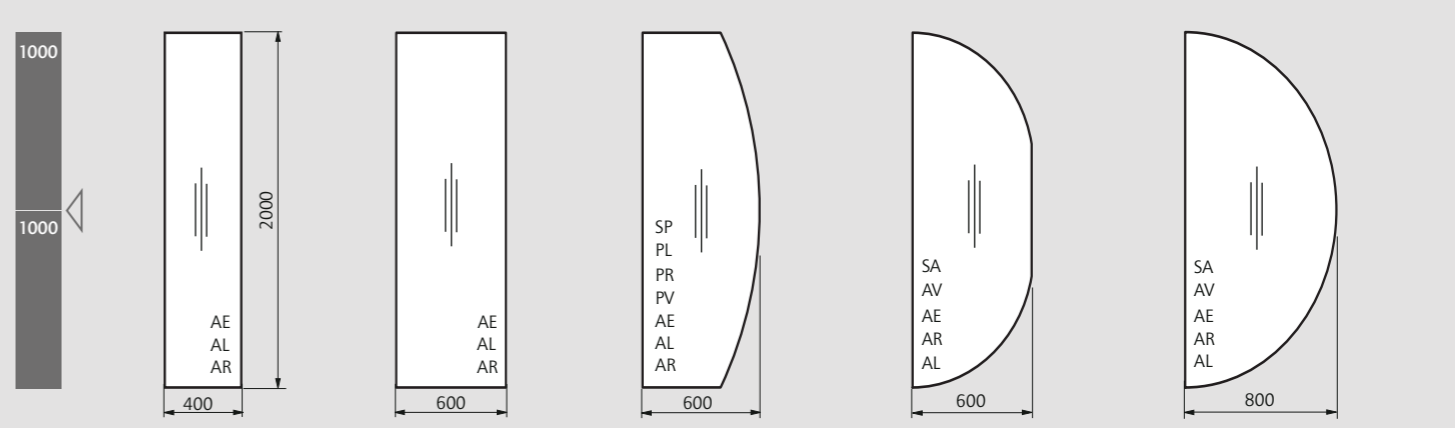
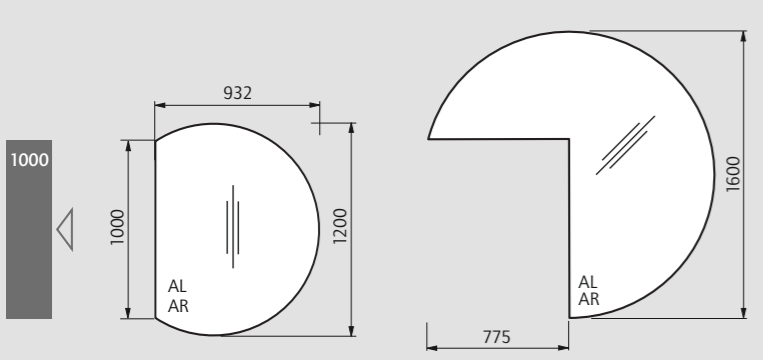
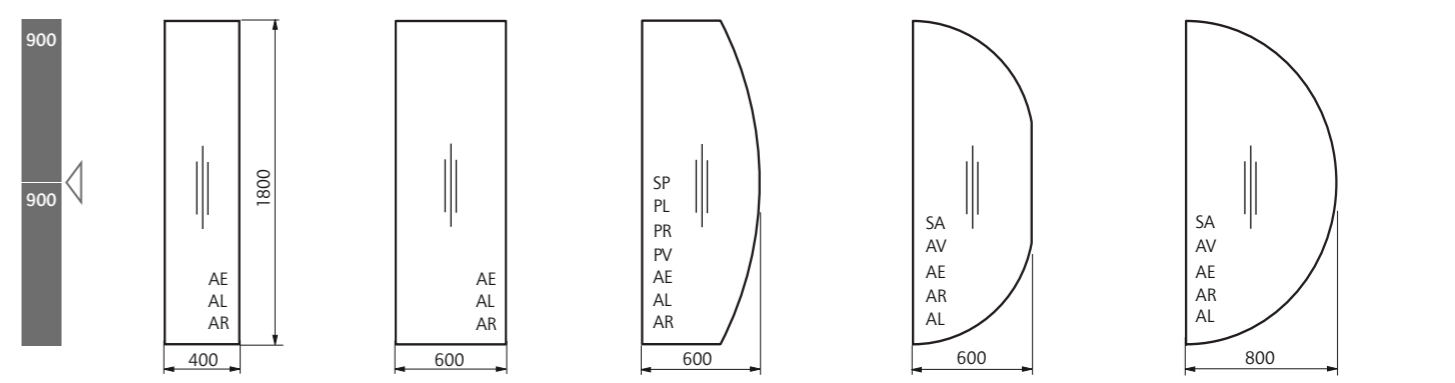
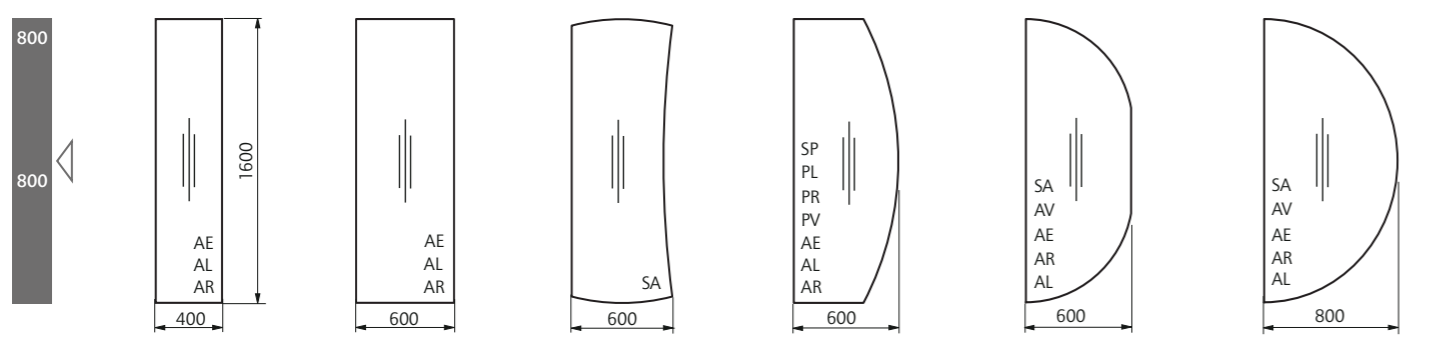
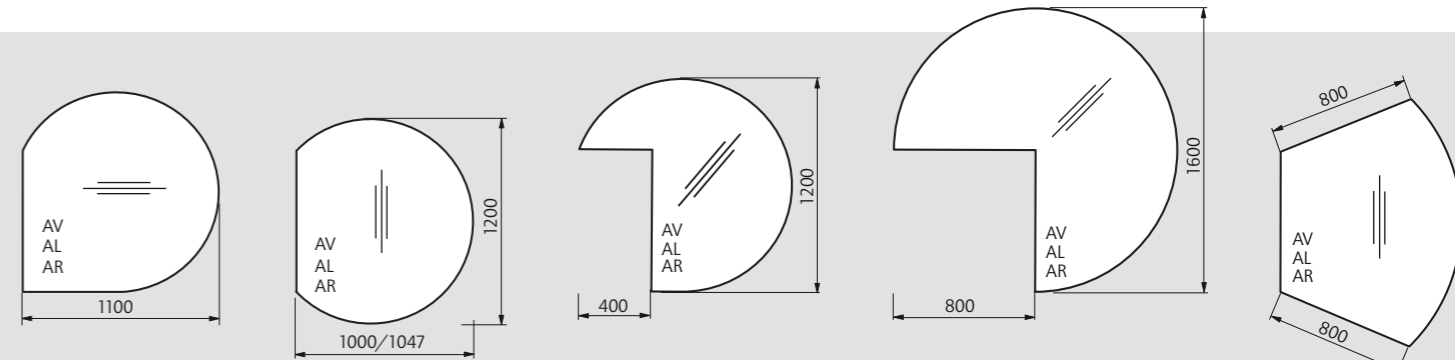
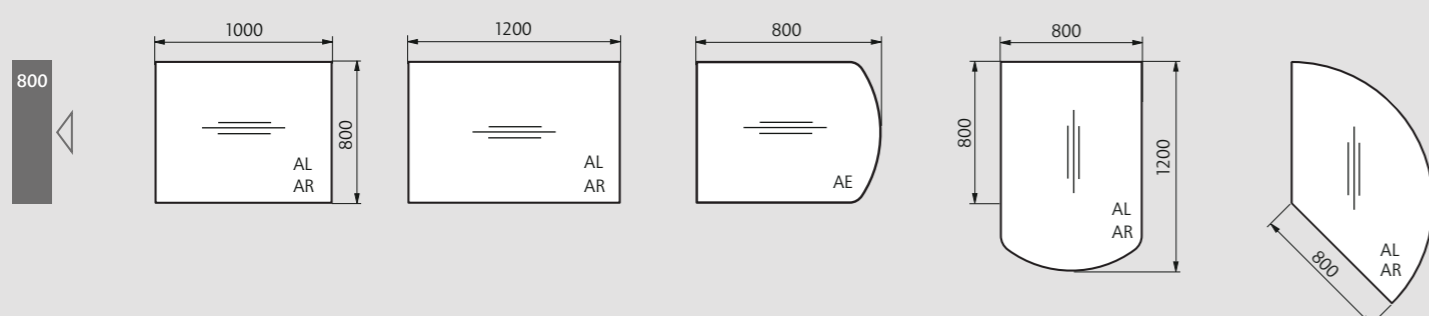
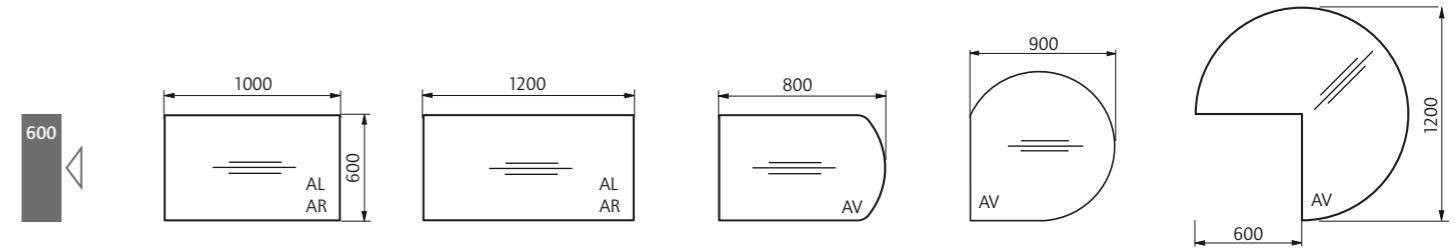



Vorsatzelemente · Modular front attachments · Voorzetelementen

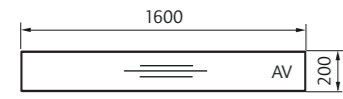

dieses Element ist erhältlich in Breite 800 bis 2000 mm · this attachment is available in width 800 to 2000 mm · dit element is beschikbaar in de breedte 800-2000 mm

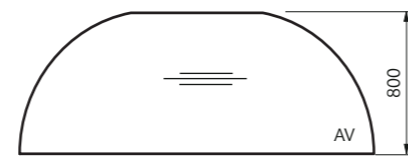
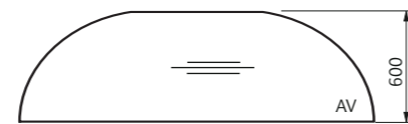
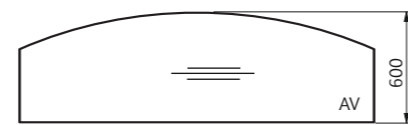
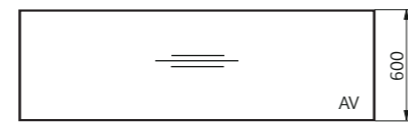
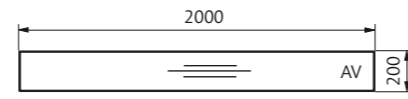
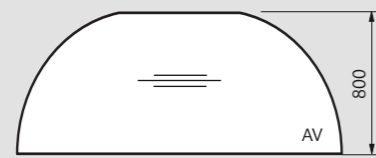
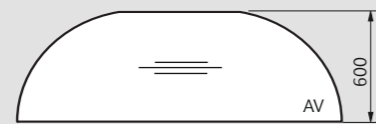
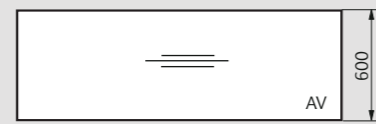
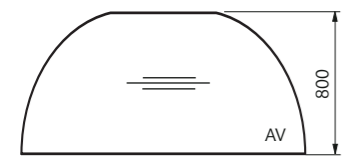
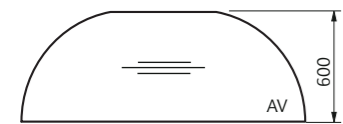
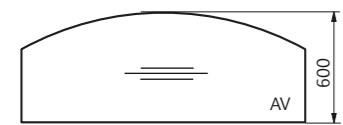
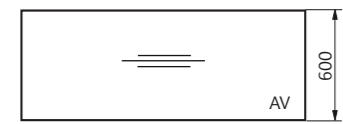
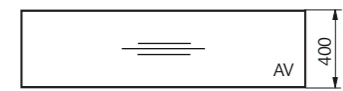

Verkettungselemente · Chain elements · Koppelementen

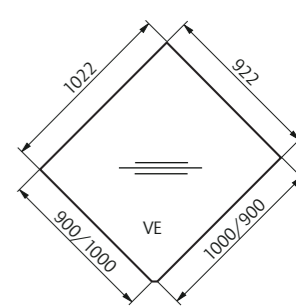
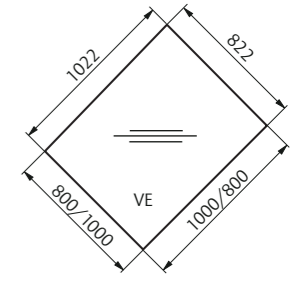
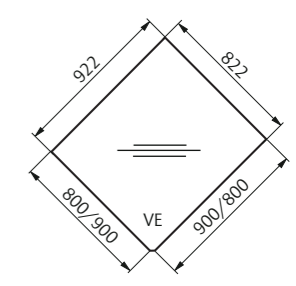
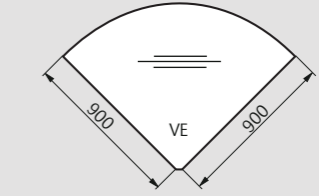
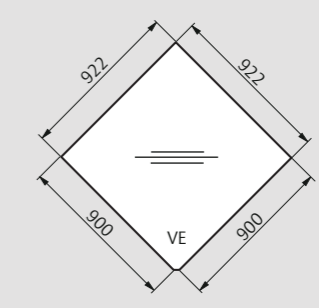
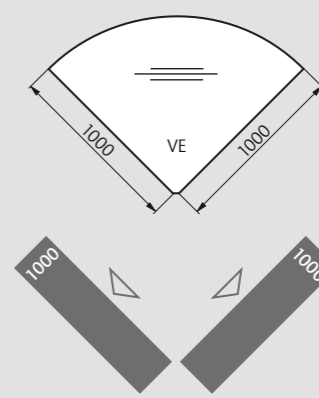
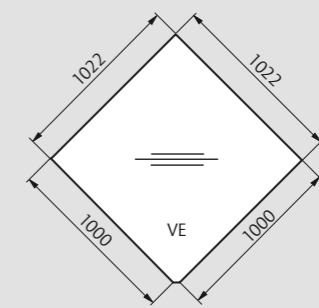
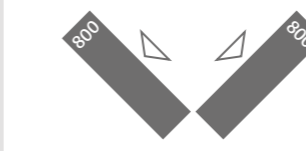
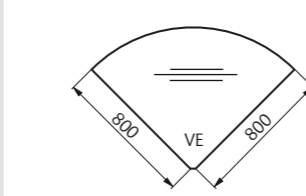
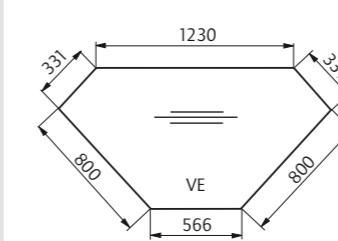
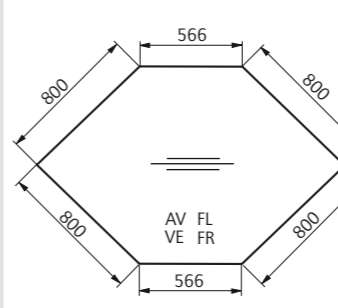
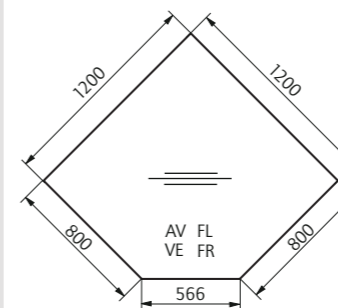
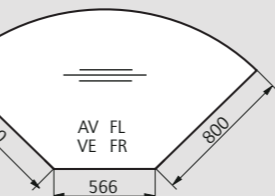
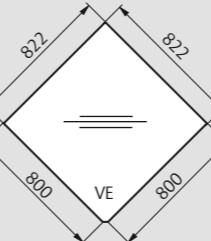
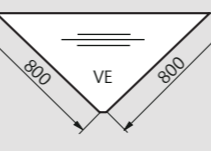
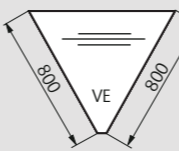
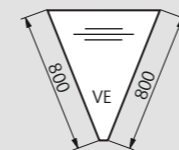



Verbindungselemente · Linking elements · Koppelbaden  
für 135° Tische · for 135° desks · voor 135° tafels

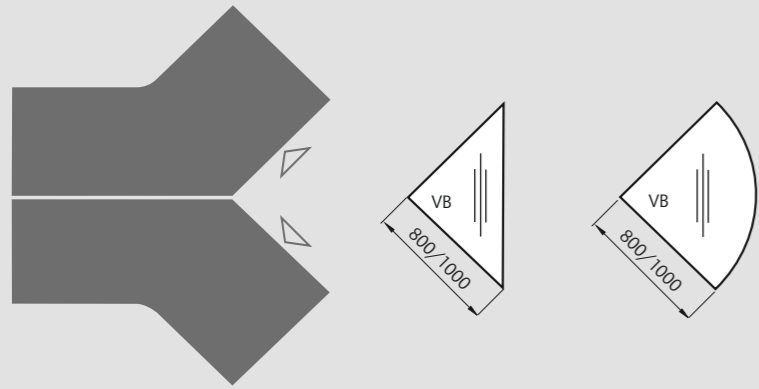

Endelemente · End elements · Eindelementen

linke und rechte Ausführung erhältlich · left and right version available · linker en rechter versie beschikbaar

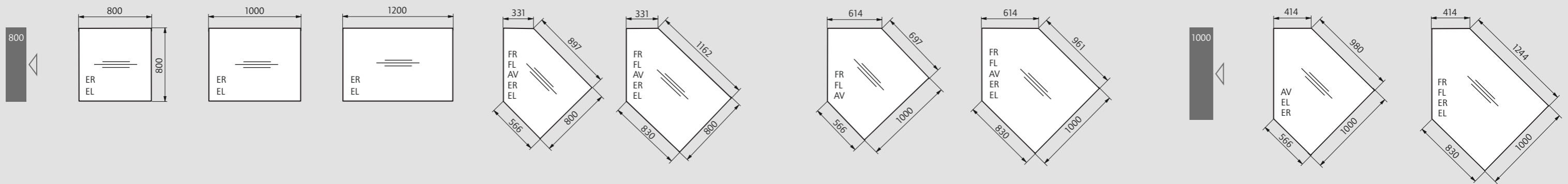
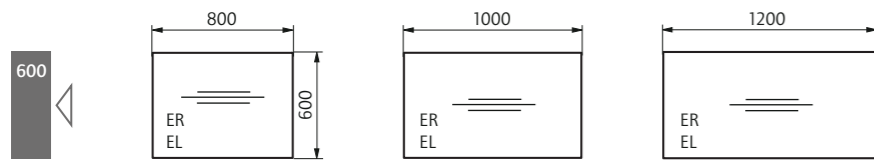



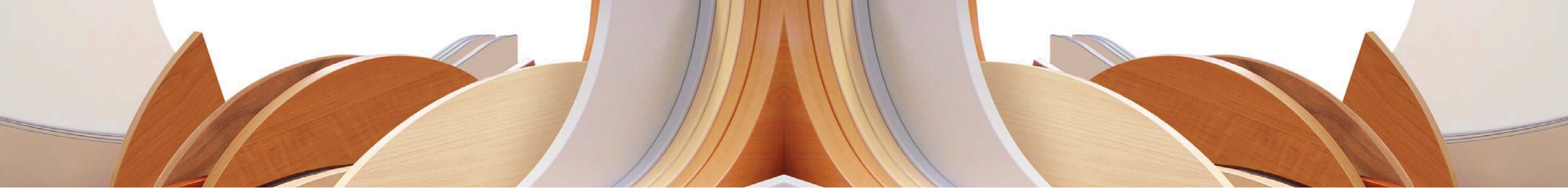

**Volldekore · Full decors · Voldecors 25 mm + 19 mm Melamin / 19 mm MDF**  
 Holzdekor · Wood finish · houtdecor

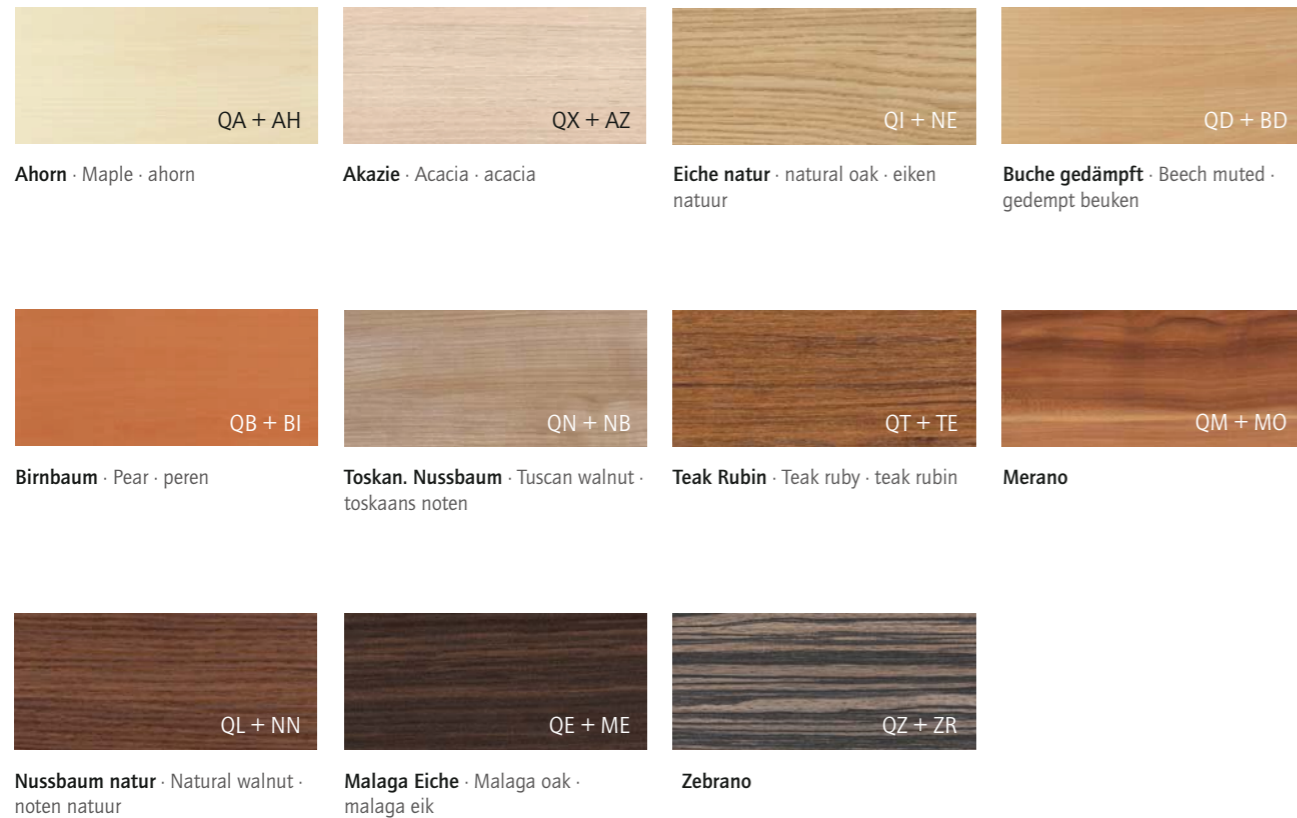

Erfahrungsgemäß können Druckfarben nicht die Brillanz der Dekor- und Gestellfarben wiedergeben. Gern wird Ihr Händler Ihnen Originalmuster vorlegen.

Experience has shown that the printed colors cannot reflect the brilliancy of the decoration and frame colors. Your dealer will be happy to present original samples.

Uit ervaring blijkt dat geprinte kleuren niet de glans van de kleuren van de decors en onderstellen kunnen reproduceren. Uw handelaar laat u graag de originele monsters zien.

**Volldekore · Full decors · Voldecors 25 mm + 19 mm Melamin / 19 mm MDF**  
 Unidekor · Plain finish · universeel decor

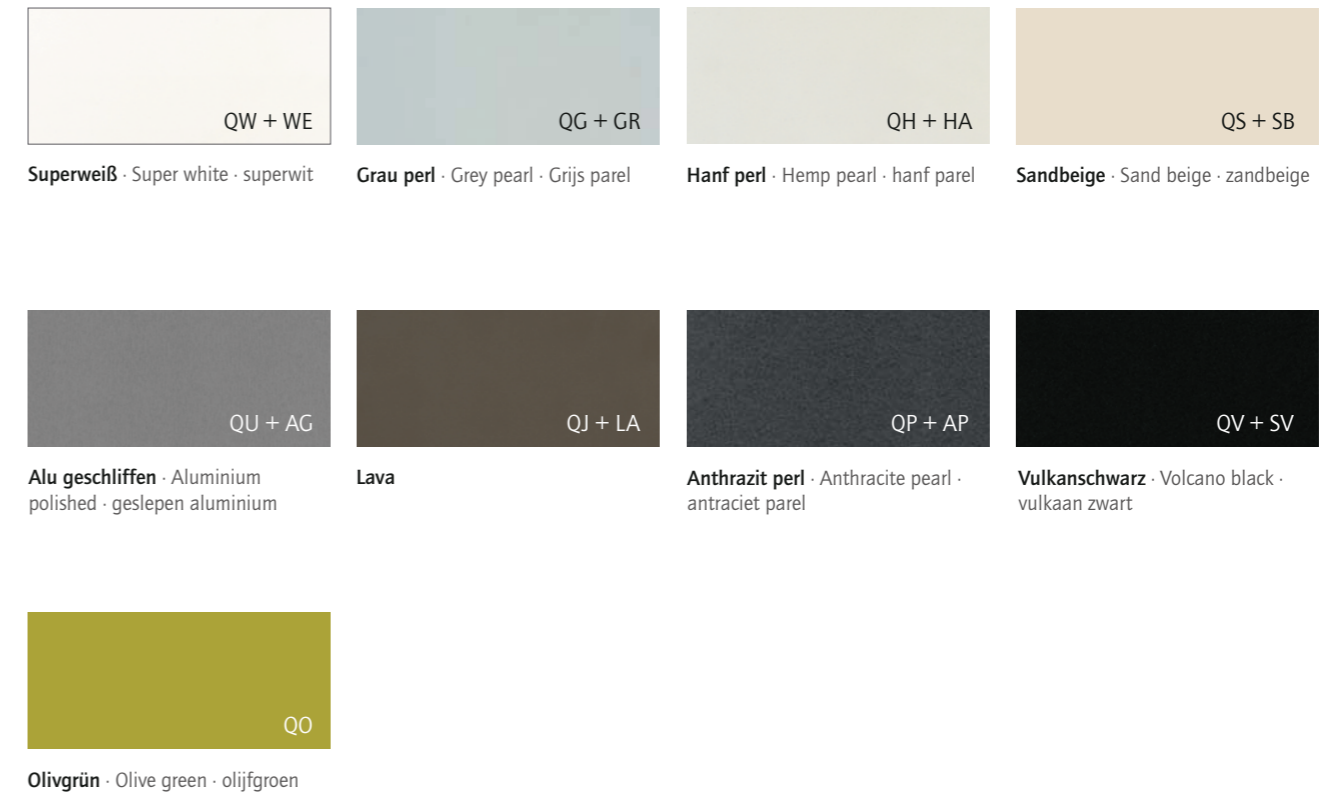

## Kompaktschichtstoff · Lamine · Volkern 12 mm

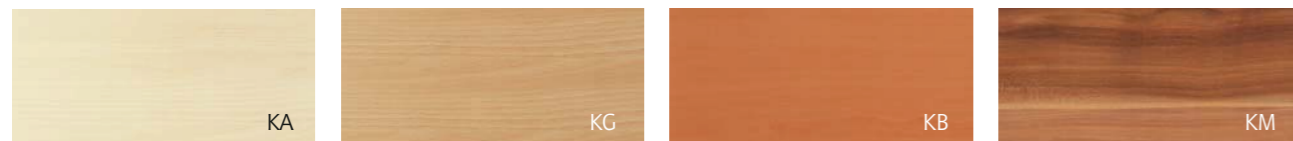

Ahorn · Maple · ahorn

KA

Buche · Beech · beuken

KG

Birbaum · Pear · peren

KB

Merano

KM

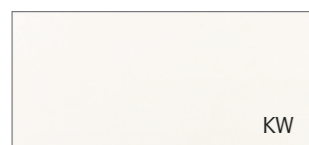

KW

Superweiß · Super white · superwit

## Furnier Preisgruppe A · Veneers price group A · Fineer prijsgroepen A 19 mm + 25 mm



Ahorn · Maple · ahorn

RA + FA

Buche · Beech · beuken

RG + FG

Eiche natur · Natural oak · Eiken natuur

RS + FS

## Furnier Preisgruppe B · Veneers price group B · Fineer prijsgroepen B 19 mm + 25 mm



Birbaum · Pear · peren

RB + FB

Amerikan. Kirsche · American cherry · Amerikaanse kers

RK + FK

Nussbaum natur · Natural walnut · noten natuur

RN + FN

Wenge · Wenge · wengé

RW + FW

### Wir setzen Ihre Tischkante in Szene!

Verleihen Sie Ihrem Arbeitsplatz den entscheidenden Akzent und nutzen Sie unsere Kantenvielfalt als Designelement in Ihren Räumen. Egal ob Sie die Kante farbgleich oder abweichend zur Tischplatte wünschen, mit unserer Kanten- und Dekorauswahl bieten wir Ihnen kreativen Gestaltungsfreiraum für Ihre Bürowelten.

### We set the stage for your table edge!

Give your workplace the decisive touch and use our variety of edges as a design element in your rooms. Whether you request the edge in the same colour as the tabletop or different from it, with our range of edges and decors we offer you creative scope for your office worlds.

### Wij geven uw bladrand een creatief accent!

Geef uw werkplek een opvallend accent en maak gebruik van onze grote keuze aan decorband als designelement voor een afwijkend detail of in hetzelfde decor als het blad. Met onze grote keuze aan decors en nu ook aan decorband bieden wij een creatieve speelruimte voor uw kantoorwereld.



### Optik wie aus einem Guss

Die perfekte Optik, eine fugenlose Verbindung und höchste Gebrauchstüchtigkeit stehen im Vordergrund der innovativen Nullfugen-Kantentechnik. Das Verbinden von Platte und Kante erfolgt dabei mit einem zielgerichteten Laserstrahl, der oszillierend eine hauchdünne Funktionsschicht der Kante reaktiviert, die im Anschluss direkt auf das Werkstück gepresst wird. Das Ergebnis: Kanten der allerhöchsten Güteklasse mit Nullfuge!

### Appears to be made of one piece

A perfect look, a joint-less connection and highest fitness for use are in the focus of the innovative zero-joint edge technology. The joining of board and edge is carried out by means of a targeted laser beam which oscillating reactivates an ultra-thin functional layer of the edge; after that, the edge is directly pressed on the work piece. The result: edges of highest quality!

### Als gegoten

De perfecte look, een voegenloze verbinding en hoogste gebruiksvriendelijkheid staan centraal in de innovatieve onzichtbare kantenband technologie. Het verbinden van plaatmateriaal en kantenband geschiedt door een doelgerichte laserstraal. Die oscillerend een dunne functielaag van het kantenband activeert, welke vervolgens direct op het plaatmateriaal geperst wordt. Het resultaat: Kantenband afwerking in de aller hoogste kwaliteit

